

RELAY_P : Relay signal lights control circuit by ik-gadgets

RELAY_P

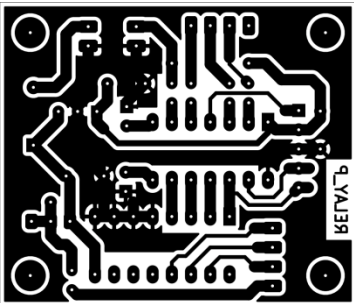

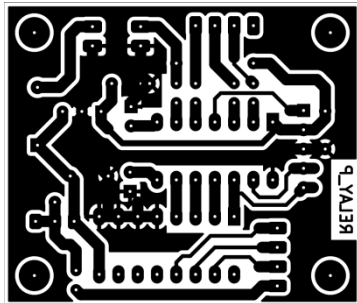
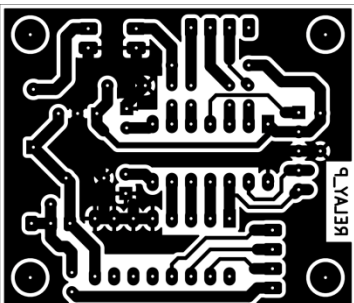
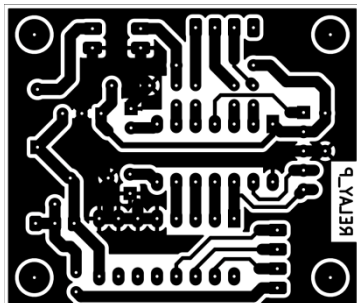
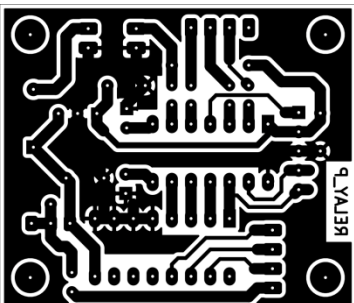
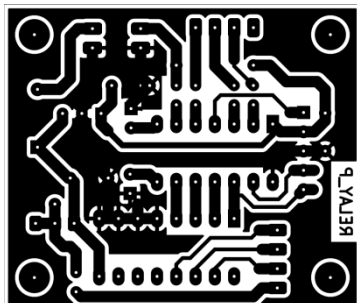
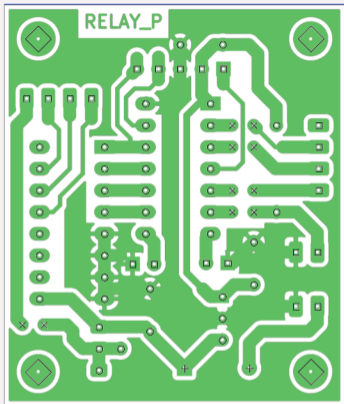

Drill Map:

×	0.70mm	/	0.028"	{	10 holes
○	0.80mm	/	0.031"	{	45 holes
+	0.90mm	/	0.035"	{	2 holes
□	1.00mm	/	0.039"	{	21 holes
◇	3.05mm	/	0.120"	{	4 holes

40.000 mm

32.000 mm

47.000 mm

39.000 mm

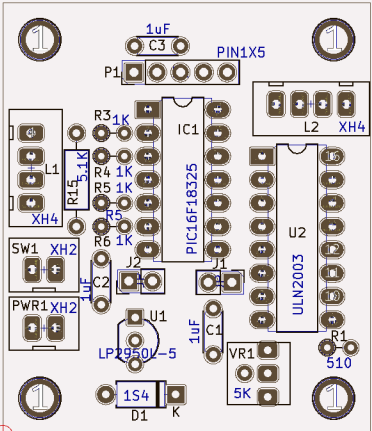

RELAY_P

